

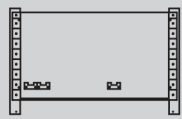

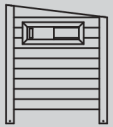







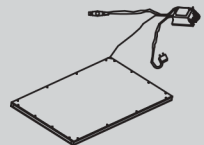
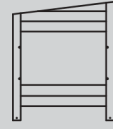

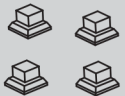







(A)  M6X80mm 5pcs	(2) 	(3) 
(B)  M6X60mm 8pcs	1pc	1pc
(C)  M6X50mm 6pcs	(4) 	(5) 
(D)  3.5X25mm 20pcs	1pc	1pc
(E)  3.0X30mm 13pcs	(6) 	(7)  1pc
(F)  3.0X16mm 13pcs	4pcs	(8)  1pc
(G)  2pcs	(9)  1pc	(10)  1pc
(1) 	(11) 	(12) 
1pc	1pc	1pc
(13) 	(14) 	(15) 
2pcs	1pc	1pc
(17) 	(18) 	(19) 
3pcs	1pc	1pc



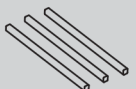

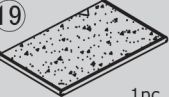
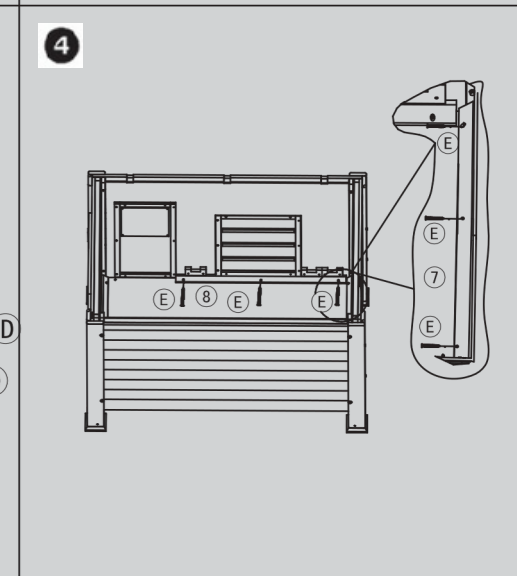
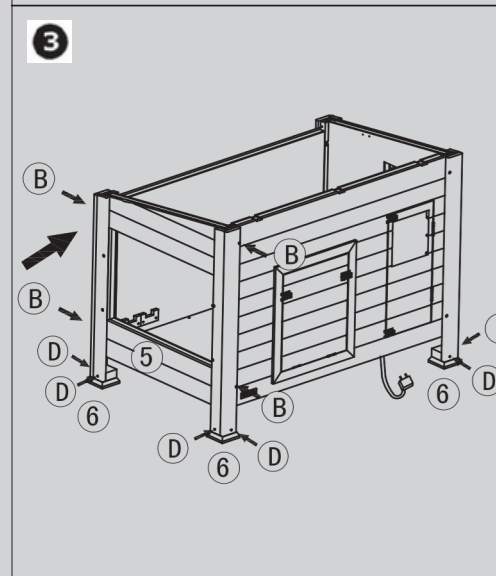
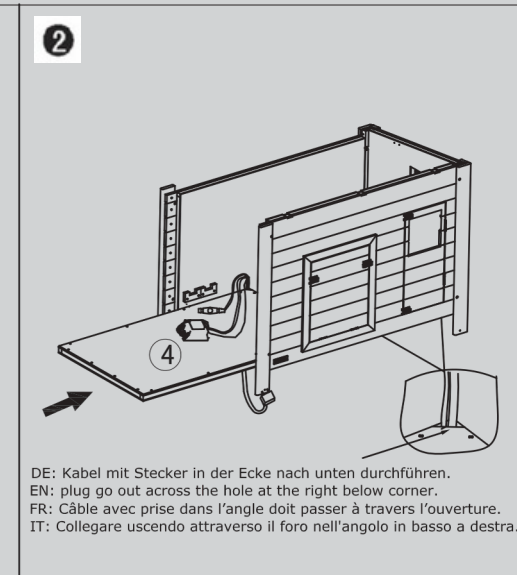
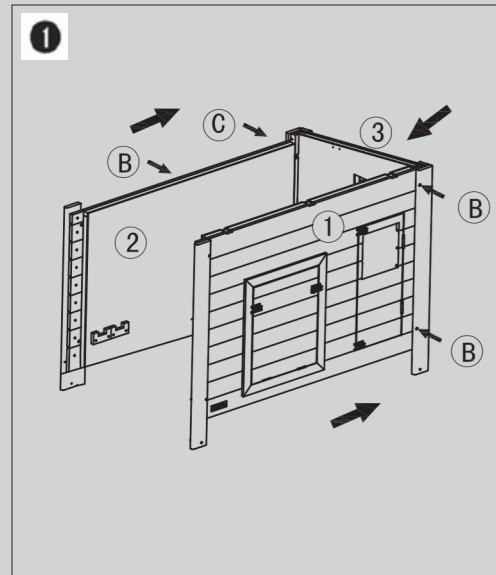
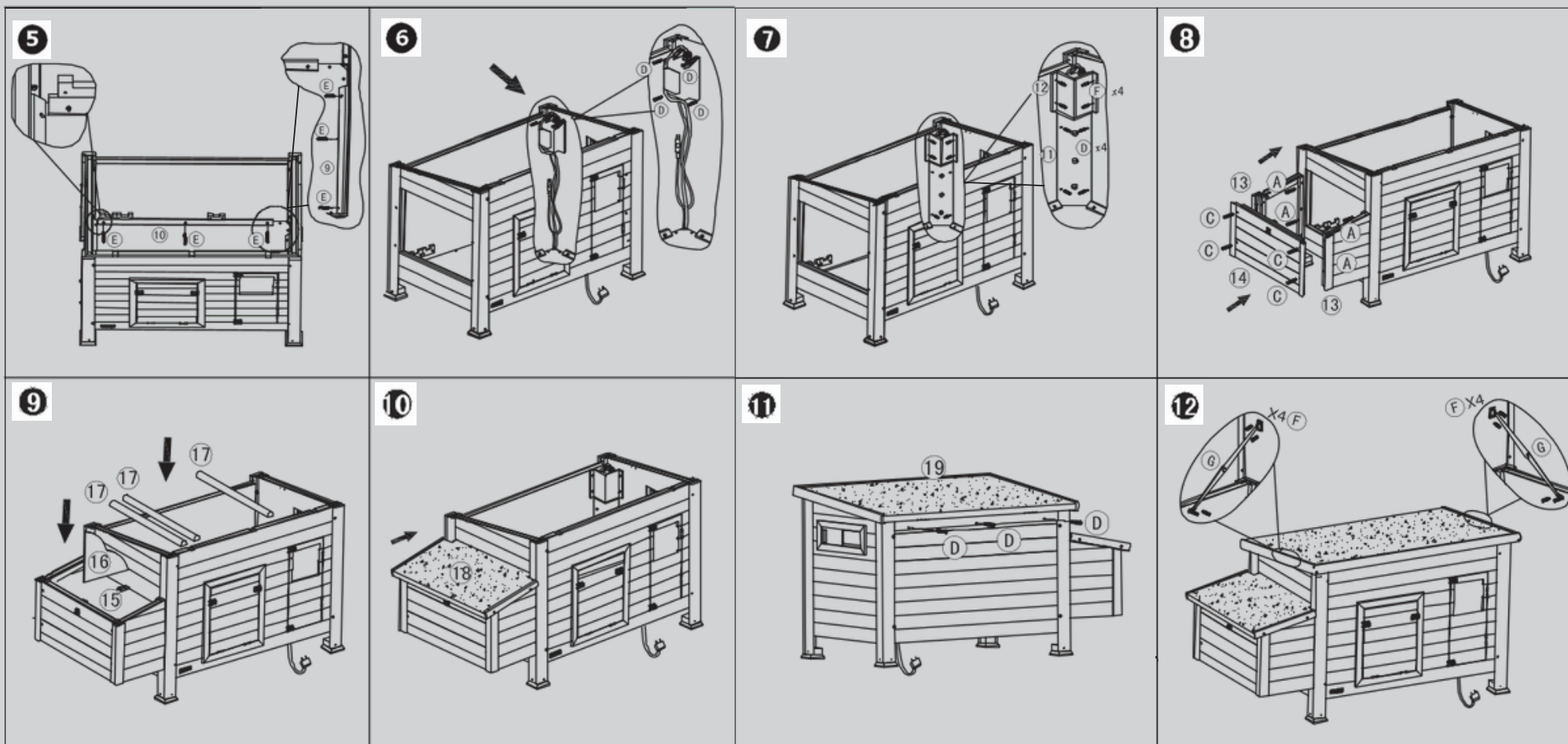
CZ: Pro prodloužení životnosti se doporučuje ošetřit dřevo vhodným dodatečným nátěrem. Nejlepší je umístit kotec pod přístřešek, aby byl chráněn před přímým působením povětrnostních vlivů.